

A New Application of Downward Continuation of Gravity Fields¹

ALBERT J. RUDMAN and MADAN M. VARMA
Geology Department
Indiana University, Bloomington, Indiana 47401

Abstract

Downward continuation of potential fields was successfully applied in 1971 in outlining the shapes of simple geologic models and in outlining the source of real fields observed in Hamilton County, Indiana. Continuation methods were applied to studies of salt domes, and preliminary results from models suggest the usefulness in determining the configuration of such economically important bodies. Oscillations which appeared to be related to the areal outline of the upper surface were observed as the field was continued downward into the body. Continuation of the field to greater depths may be useful in detecting major changes in outline of the dome below its upper surface.

Introduction

Although the seismic reflection method constitutes the most important geophysical exploration tool today, gravity and magnetic surveys continue to play an integral role in the study of subsurface geology. Recent developments of air and shipboard gravimeters have focused renewed attention on the use of gravity and magnetic data in industrial exploration for ore and petroleum reserves.

Instrumental developments have stimulated numerous scientific papers on gravity interpretation. Some scientists are investigating how classic methods of interpretation can be improved by computer technology. Others have considered entirely new interpretation concepts, mainly by investigating the behavior of fields in the frequency domain. Development of new interpretation methods is well summarized in a recent paper by Grant (2). In this report we present some new results for a classic method of analysis: *downward continuation of potential fields* (especially gravity fields).

Downward Continuation

Standard Applications

Downward continuation was discussed in several early papers (1, 5) and more recently in two fundamental papers by Roy (6, 7). In its simplest form, the method of downward continuation allows gravity data mapped at the surface of the earth to be analyzed and the values that would theoretically occur at various depths beneath the surface to be calculated.

The method and application were clearly illustrated by Henderson (4). He computed the theoretical gravity anomalies over two spheres buried $Z = 10$ depth units (Fig. 1). The anomaly at the surface ($Z = 0$) was shown in cross section as a bell-shaped curve. Inspection

¹ This study was funded in part by the Indiana Geological Survey and the Schlumberger Foundation. The Indiana University Research Center provided the use of a Model C.D.C. 6600 computer.

of this curve indicated the presence of only one buried source. Downward continuation to lower levels ($Z = 5$) eventually separated the single anomaly into two distinct humps, each hump overlying one of the spheres. This is the classic application: continue the observed field downward toward the source to increase resolution.

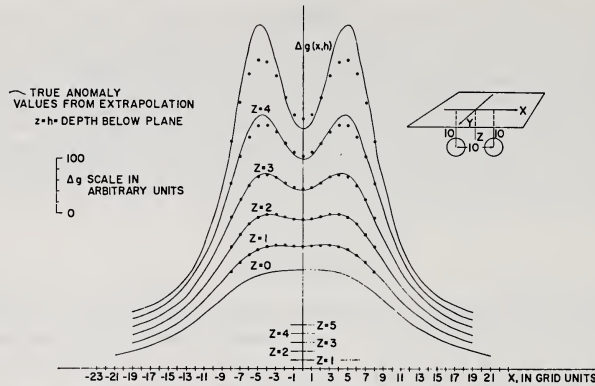

FIGURE 1. Gravitational anomalies over two spheres buried $Z = 10$ units. Anomaly at the surface ($Z = 0$) was continued downward to 5 different levels. (After Henderson (4)).

Theory

As summarized by Roy (7), downward continuation of a field can be developed from a Taylor Series expansion of the data or from decomposition of the data into its spectral components. In this study we used a computer program following the method of Henderson (4). The observed field was digitized using a square grid pattern with points spaced a distance Z units apart. Downward continuation was calculated in units of the grid interval (up to a maximum of $Z = 5$) using sets of coefficients developed by Henderson (4).

There is both theoretical and empirical justification for *not* continuing an observed anomaly below the top of the source of that anomaly. Given an observed gravity (or magnetic) field at a level $Z = 0$ (Fig. 2), the horizontal dimensions of the anomaly will be wider than the mass producing it. As it was continued downward, the width of the anomaly decreased until it reached a limiting point approximating the size of the source ($Z = 1.0$). Continuation below this level was marked by oscillations of the field. Presence of oscillations were then used to determine the top of the mass.

An excellent application of this theory of oscillations was illustrated by Roy (6). He showed (Fig. 3) that the magnetic field over an ore body buried 60 feet began oscillations somewhere between 2 and 3 depth units (50 to 75 feet deep). Analysis of where an anomaly begins to lose its regular share and begins to oscillate may be criticized as subjective. Therefore, Roy also plotted semi-log values of peak oscillations (insert on Fig. 3) and observed a maximum curvature at 2.6 depth units (65 feet). It should be noted that Roy was not successful when applying similar methods to a *gravitational* field.

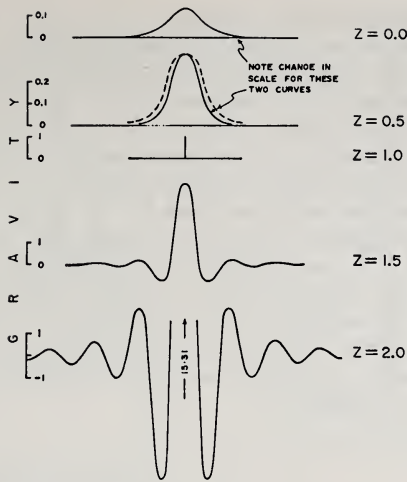

FIGURE 2. Gravity anomaly over a mass with unit gravity at a level $Z = 1.0$. Oscillations appear only at deeper levels. (After Roy (6)).

A New Application

Analyses of a geologic source with vertical sides (*i.e.*, a vertically prismatic body) is a simpler task than analyses of an irregular shaped body. For example, the shape of a vertical prism is readily outlined by the half-maximum values of its anomaly. Depth to the top of such a source is also easily calculated from half-maximum values. However, when the source has non-vertical sides, the problem becomes more complex.

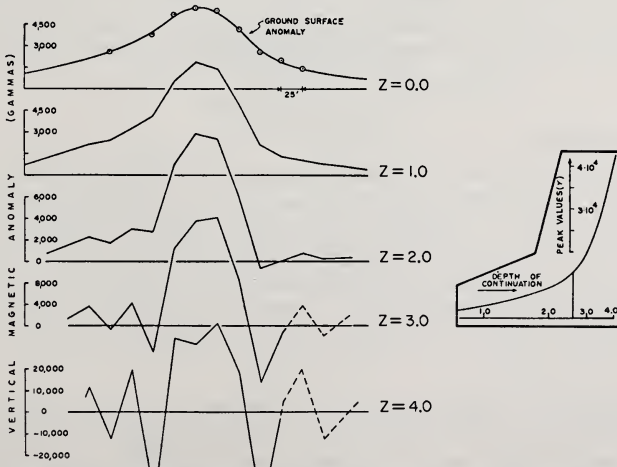

FIGURE 3. Vertical magnetic anomaly and downward continuations over an ore body at level $Z = 2.4$. Ground surface anomaly at $Z = 0$. (After Roy (6)).

Downward continued field serves as a basis for a new type of analyses in the case of non-vertical geometries. We recognize that the source of a potential field can never be uniquely determined from the measured field. Nevertheless, Rudman *et al.* (8) showed that given certain assumptions a geometric form with sloping sides (Fig. 4) may be approximately definable by the presence of oscillations. The half-maximum value of the original anomaly outlines the source as long as the field is not continued below its top ($Z=0$). If the field is continued below the top, oscillations begin to appear at the edges of the anomaly ($Z=1$). The central part of the anomaly may have large values but its shape should retain a smooth form. Instead of half-maximum values outlining the source at the continued depth, the presence of oscillations outlines the source. If the field is continued further into the source ($Z=3$), large oscillations can be expected to dominate the entire anomaly.

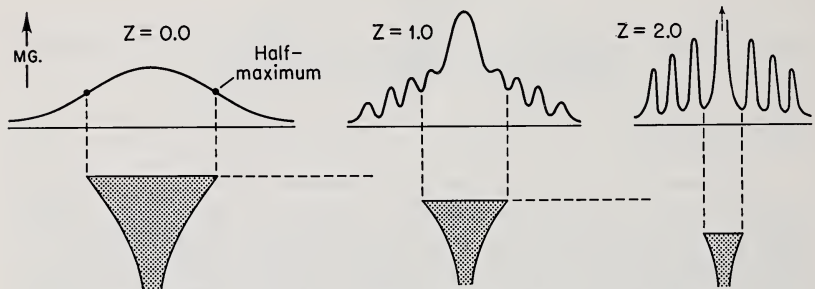

FIGURE 4. Sketch of theoretical anomaly over a source with non-vertical sides.

In the study of a magnetic anomaly in Hamilton County, Rudman *et al.* (8) successfully outlined a source by downward continuation of a magnetic anomaly. Analyses of the gravitational field was less successful and questions remained concerning the validity of the method.

Gravity Model Study

Salt Dome Models

Many case histories have demonstrated the validity of gravity fields in detecting the presence of salt domes and in calculating the depth to their upper surfaces. Defining the geometric shape of a dome is a more difficult problem, especially the determination of the size of the overhang portion. Continuation methods seem to be applicable to this type of geologic problem. Halbouty (3) showed a salt dome in cross section with overhang (Fig. 5) and illustrated the possible entrapment of oil beneath the overhang.

Simplified salt dome models were created for this study for overhang thicknesses of 500, 1,000 and 1,500 feet (Fig. 6). Three-dimensional gravity fields were calculated and contoured maps prepared. These model maps were then continued downward in steps of 500 feet and cross sections constructed along line AA'.

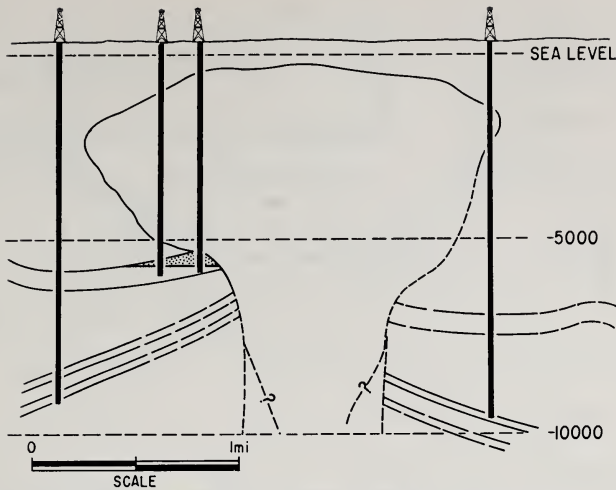

FIGURE 5. Cross section of Bethel Salt dome in Anderson County, Texas. Note accumulation of oil beneath the overhang. (After Halbouty (3)).

Results

Cross sections over a model with a 500 foot-thick overhang (Fig. 7) show that the anomaly retains its regular shape until the field has been continued downward 2 or 3 units (1,000 to 1,500 feet below the surface). At these levels of continuation, oscillations begin to appear along the edges of the anomaly indicating we have continued below the overhang in that region.

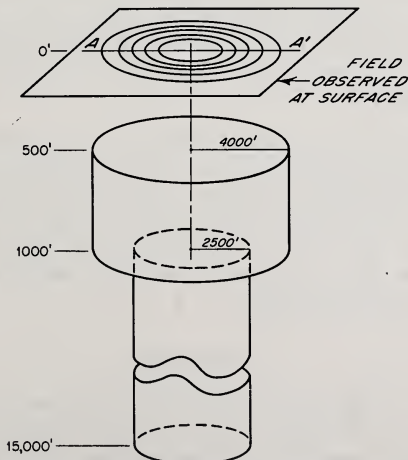

FIGURE 6. Salt dome model used to compute three separate gravity maps (for overhang thicknesses of 500, 1,000 and 1,500 feet).

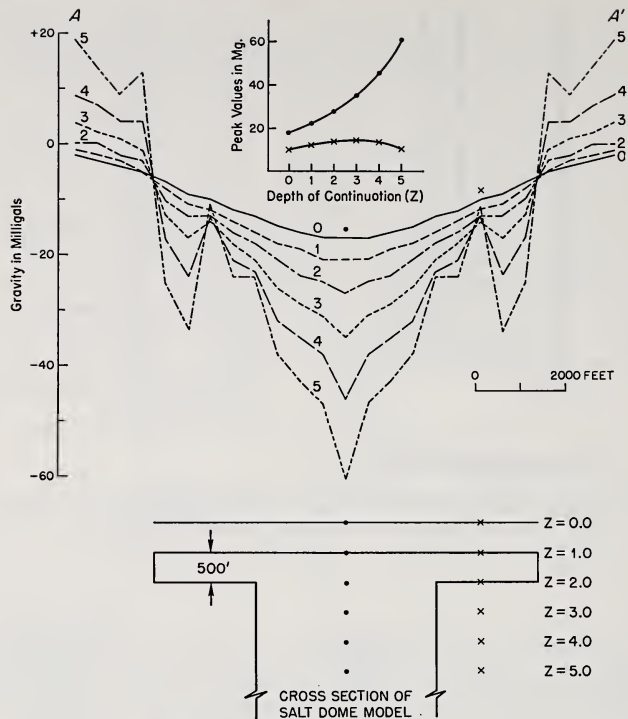

FIGURE 7. Gravitational anomaly ($Z = 0$) calculated over a salt dome buried 500 feet. The anomaly was continued downward to five levels each 500 feet apart. A plot of peak values at two locations shows variation of gravity with downward continuation.

A detailed plot (Fig. 7) of two selected points (one over the center of the dome, and the other over the overhang) show that (a) values over the center increased regularly for all five continuations and (b) values over the overhang began to *decrease* as the field was continued through the overhang.

Only minor differences were observed for models with 1,000 and 1,500 feet of overhang. The fields of these models show oscillations appearing about 1,500-2,000 feet down (again below the overhang). In cross section the peak values over the central part of the anomaly continued to increase regularly (as predicted) for all values of continuation. However, the *rate of increase diminished* when the field was continued below the overhang portion.

Conclusions

Continuation of gravity fields over non-vertical geometries may be able to define gross changes in shape of the source. In the special case of a salt dome, sensitivity of the method was less than expected. Detection of the overhang was possible, but only minor differences observed for thicknesses varying from 500 to 1,500 feet.

Literature Cited

1. EVJEN, H. M. 1936. The place of the vertical gradient in gravitational interpretations. *Geophysics* 1:127-136.
2. GRANT, F. S. 1972. Review of data processing and interpretation methods in gravity and magnetics, 1964-1971. *Geophysics* 37:647-661.
3. HALBOUTY, M. T. 1967. *Salt Domes: Gulf Region, United States and Mexico*. Gulf Publishing Co., Houston, Texas. 425 p.
4. HENDERSON, R. G. 1960. A comprehensive system of automatic computation in magnetic and gravity interpretation. *Geophysics* 25:569-585.
5. PETERS, L. J. 1949. The direct approach to magnetic interpretation and its practical application. *Geophysics* 14:290-320.
6. ROY, A. 1966. The method of continuation in mining geophysical interpretation. *Geoexploration* 4:65-83.
7. _____. 1967. Convergence in downward continuation for some simple geometries. *Geophysics* 32:853-866.
8. RUDMAN, ALBERT J., J. MEAD, J. F. WHALEY, and R. F. BLAKELY. 1971. Geophysical analysis in central Indiana using potential field continuation. *Geophysics* 36:878-890.